













-  Markierung einzeichnen / Make marking / Marquage
-  Tesafilm / Clear Tape / Ruban adhésif
-  Mit scharfem Messer schneiden / Cut with a sharp knife (Exacto) / Utiliser un cutter
-  Kante mit Tesafilm umkleben / Seam the edges with clear tape / Recouvrir les bords avec du ruban adhésif
-  Mit CA-Kleber verkleben / Use CA-glue / Utiliser de la colle cyano
-  Mit Epoxy Harz verkleben / Use epoxy glue / Utiliser de la résine Epoxy
-  Mit **UHU por** ohne Ablüften verkleben / Use **UHU por** glue without drying / Utiliser colle **UHU por**
-  **UHU por** vor Zusammenbau 10 Min. ablüften lassen / Let **UHU por** dry for 10 min. before joining surfaces together / Utiliser colle **UHU por**. Laisser sécher 10 min. avant assemblage
-   Ruder 45° anschrägen / Send rudder edge in 45° angle / Chanfreiner la gouverne à 45°
-  Siehe Hinweise in den „Expertentips“ / See „Expert tips“ / Voir des „Conseils d'experts“
-  Ruder mit einem Tesastreifen befestigen / Attach rudder with clear tape / Fixer la gouverne sur le dessus avec du ruban adhésif
-  Anschließend von unten 3 kurze Tesastreifen zur Verstärkung anbringen / Reinforce from bottom with 3 short stripes of tape / Fixer la gouverne sur le dessous avec trois autres petits bouts de ruban adhésif

1

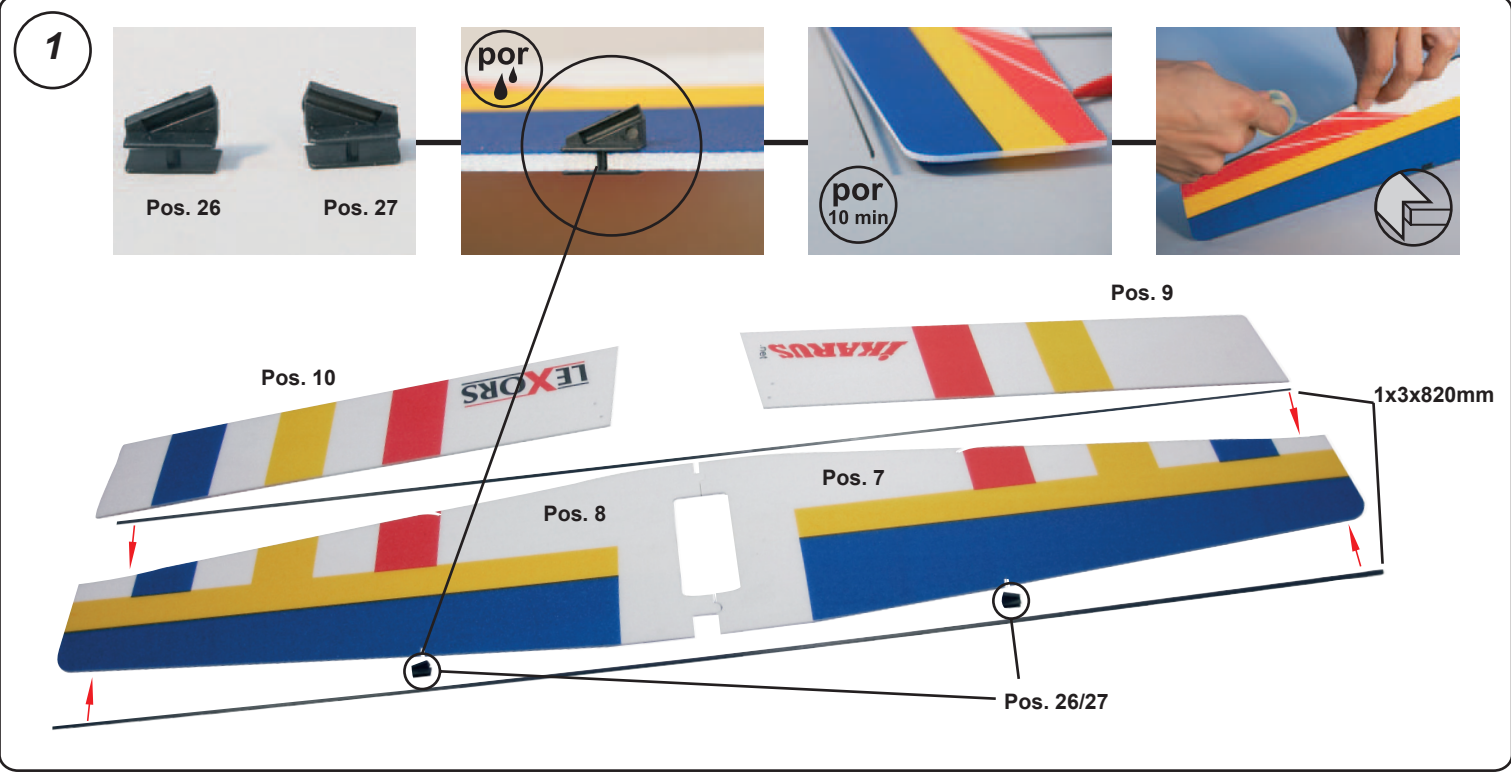

Pos. 26 Pos. 27

Pos. 9

Pos. 10

Pos. 8

Pos. 7

1x3x820mm

Pos. 26/27

por 10 min

2





LEXORS

IKARUS

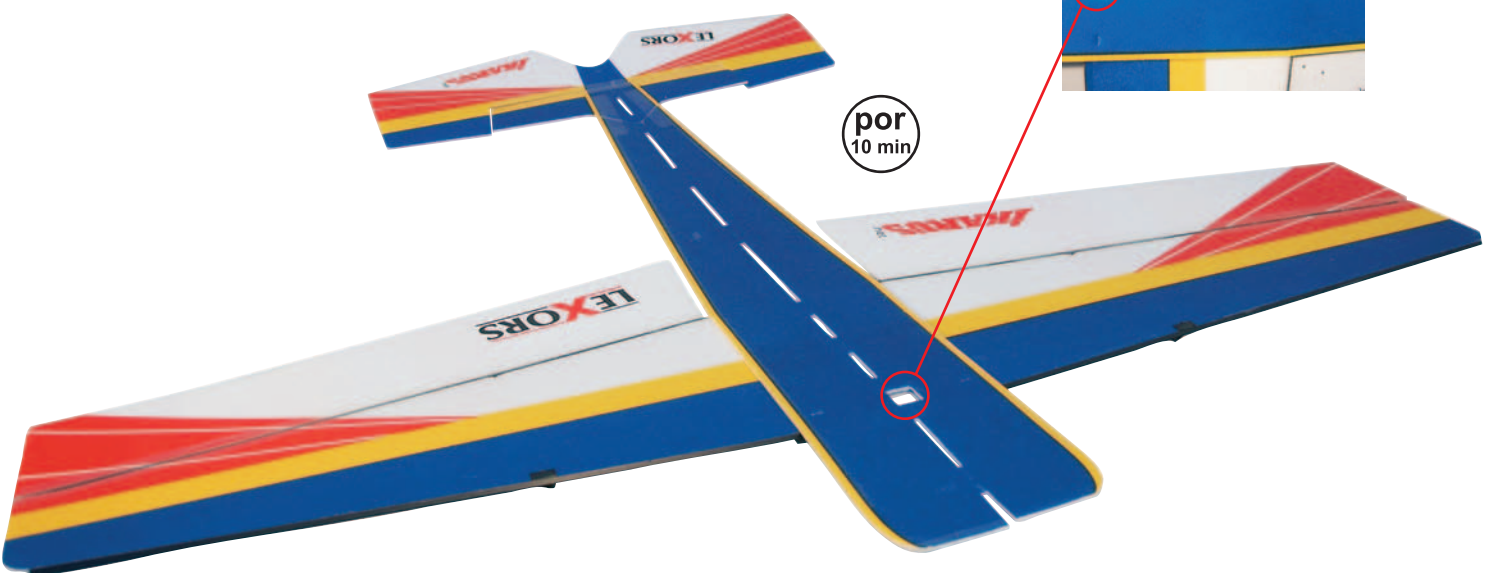
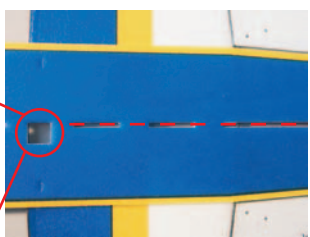
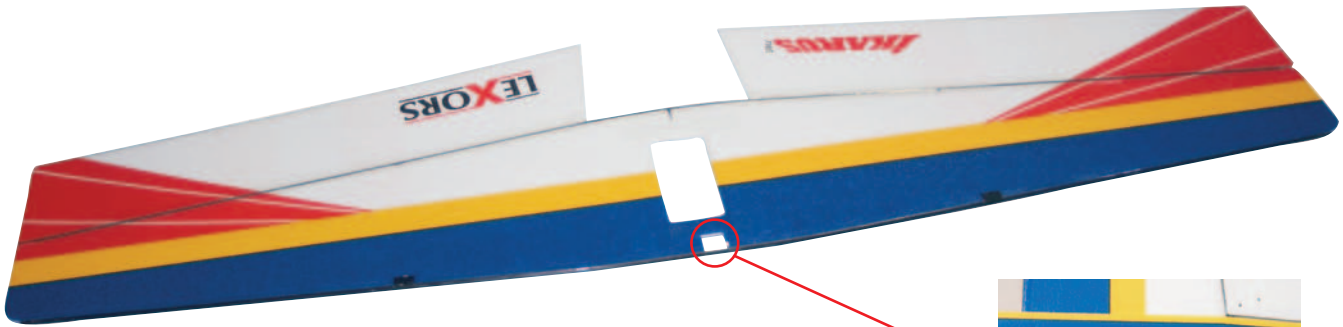
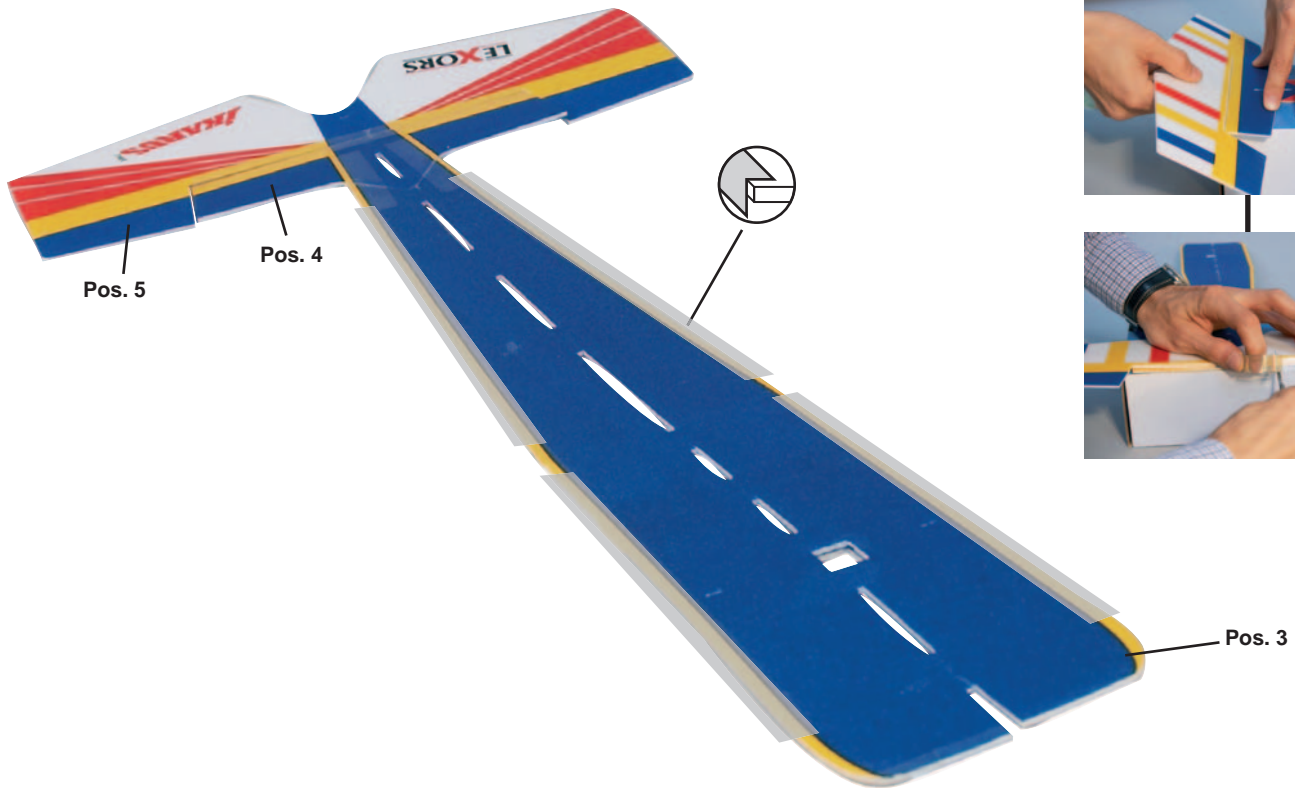
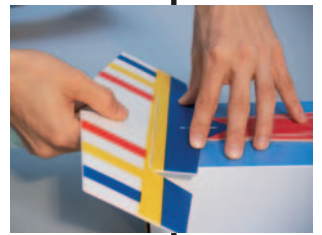
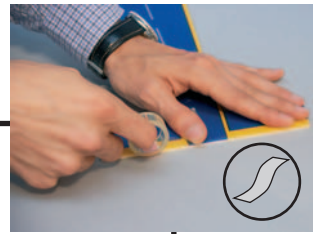
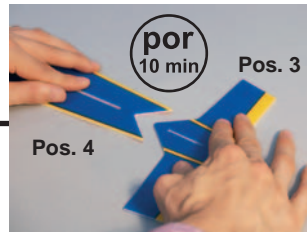
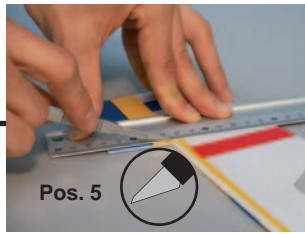
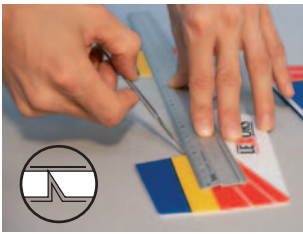
3

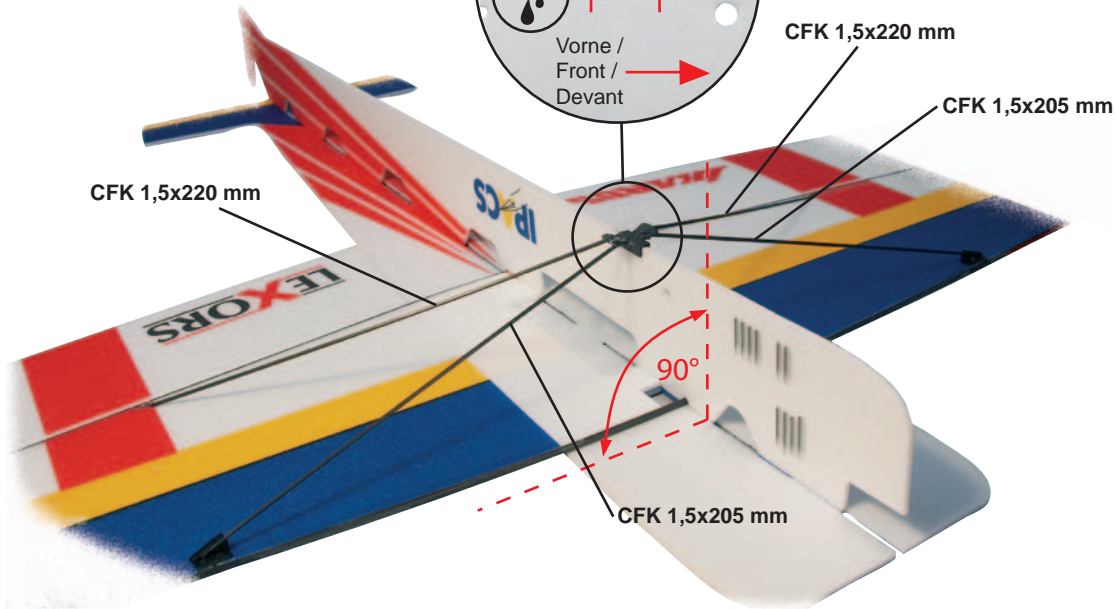
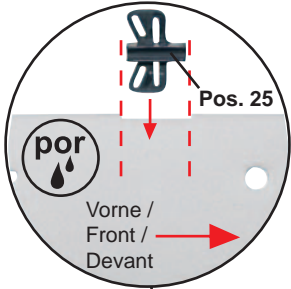
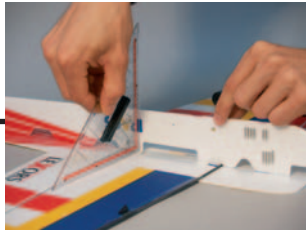
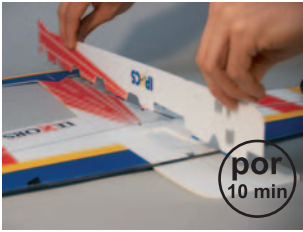

4



5

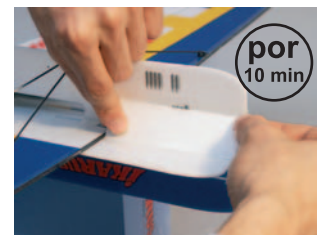
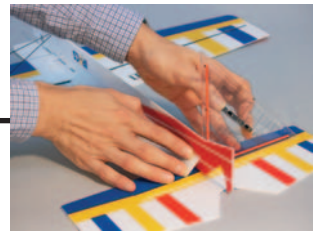

Pos. 15

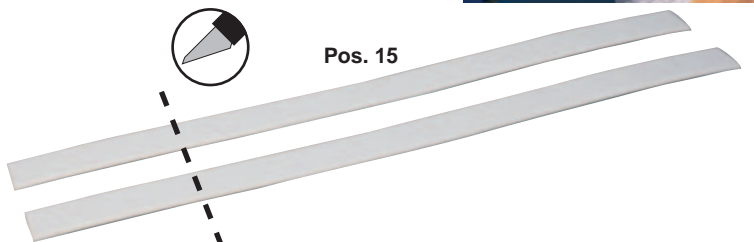

6

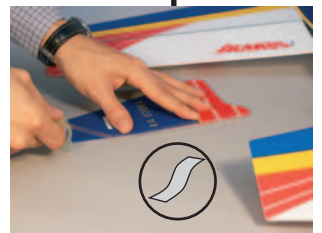
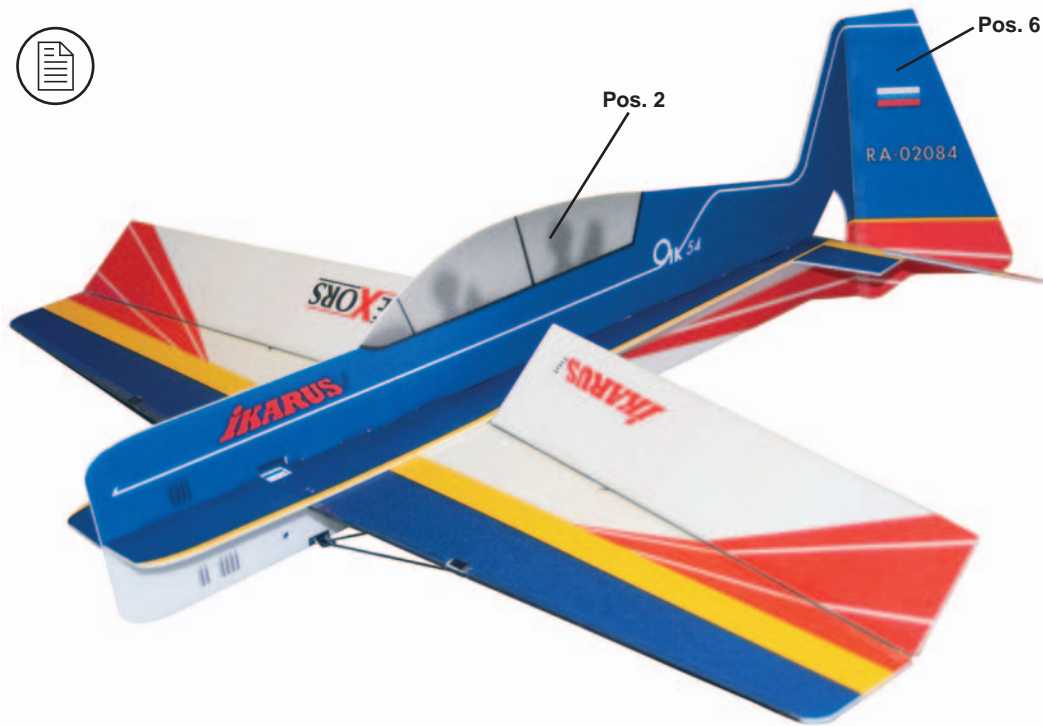
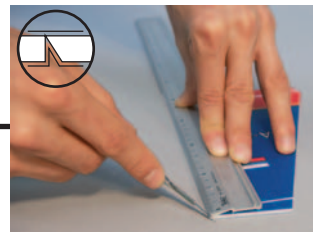
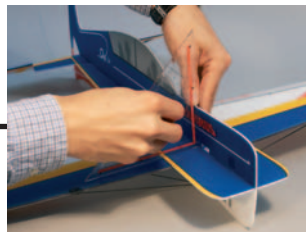

7

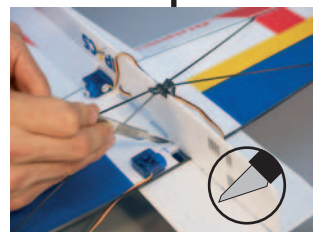
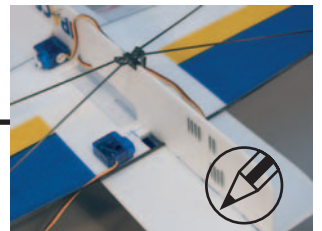
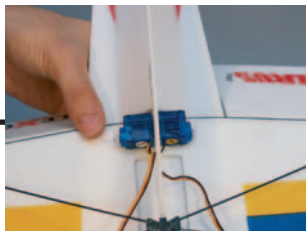
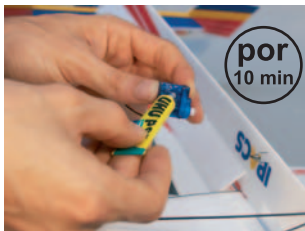

8

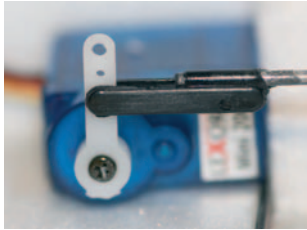
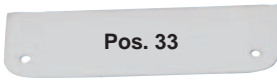
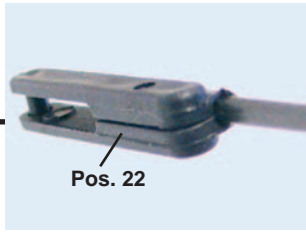

Anfänger / einfacher Kunstflug
Novice / Basic aerobatics
Débutant / Voltige simple



Experte / 3D Kunstflug 25-60 % Expo
Expert / 3D aerobatics with 25-60 % Expo
Expert / Voltige 3D 25-60 % d'Expo

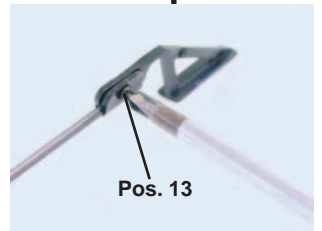
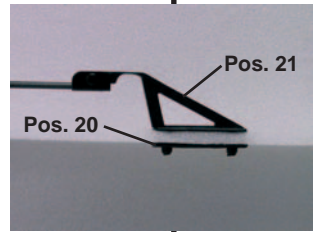
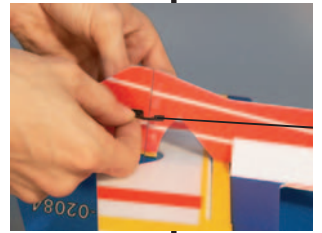
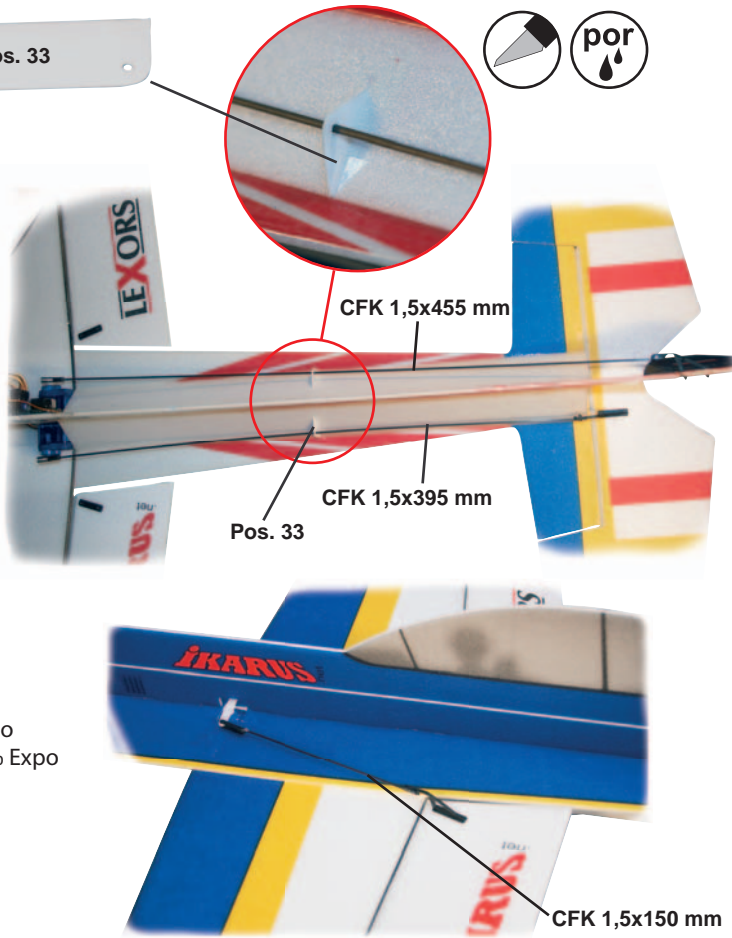

9

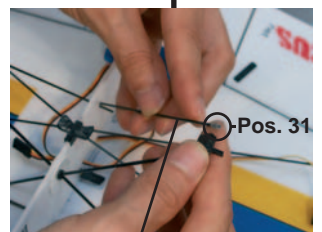
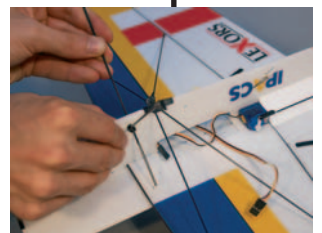
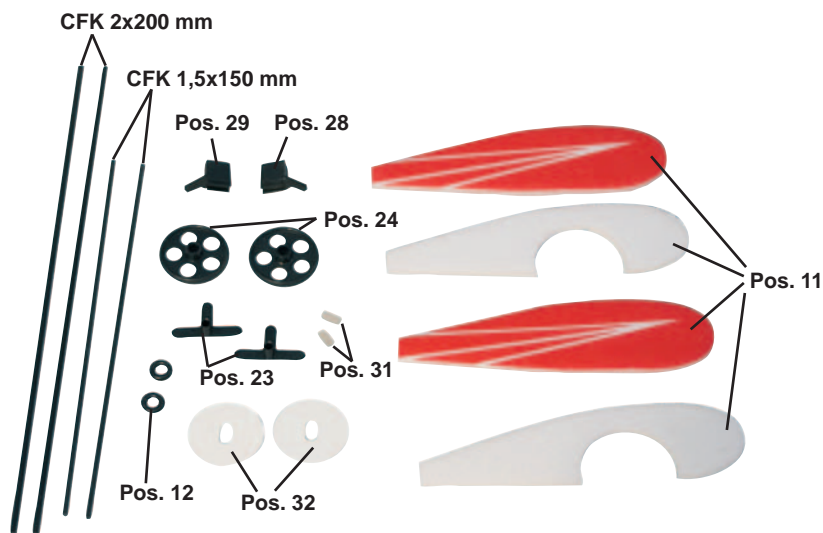
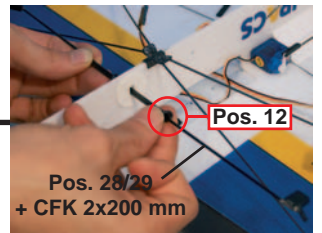
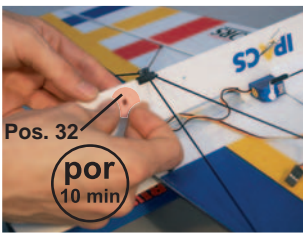

CFK 1,5x150 mm

9

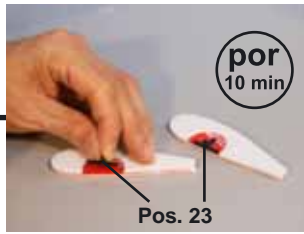

10a

Standard

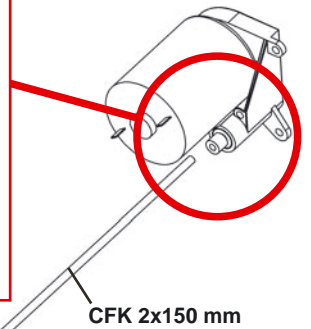
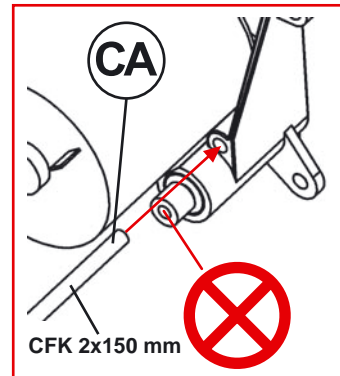
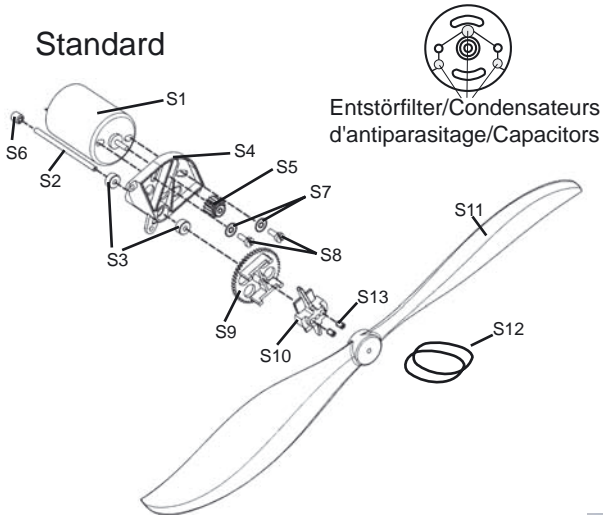

Pos. 19

por 10 min



Schwerpunkt /
CG position /
Centre de gravité

Nemesis /
YAK 54 /
F3A

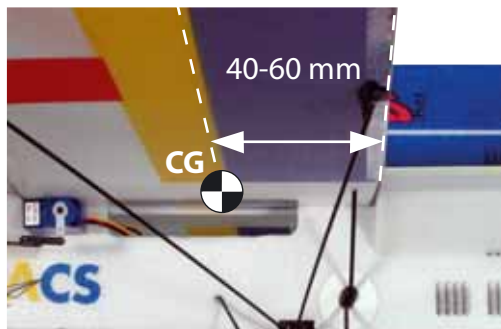

Schwerpunkt durch Akku-
position auswiegen /
Balance CG with battery /
Centrer le modèle en déplaçant l'accu



10b

Brushless

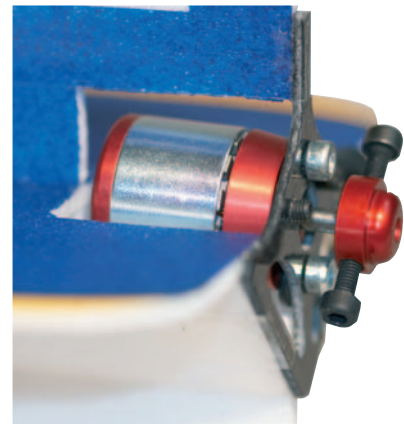
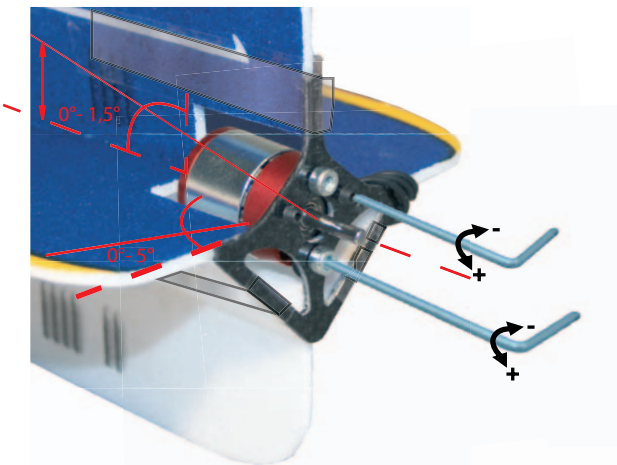
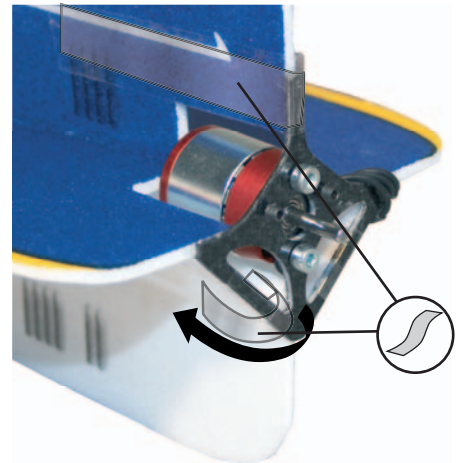
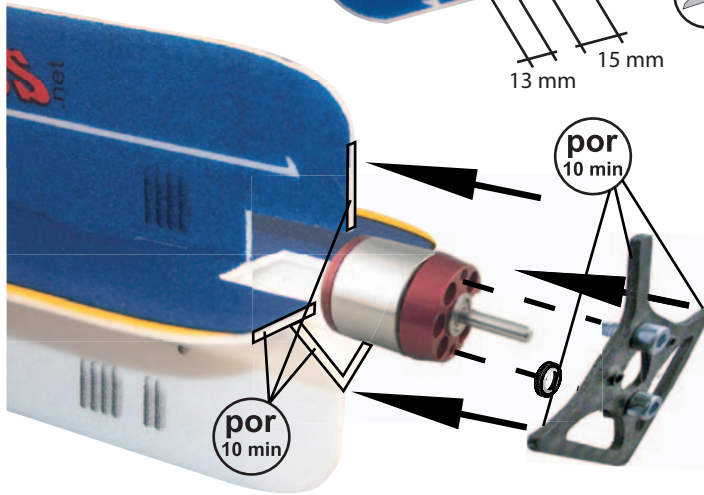
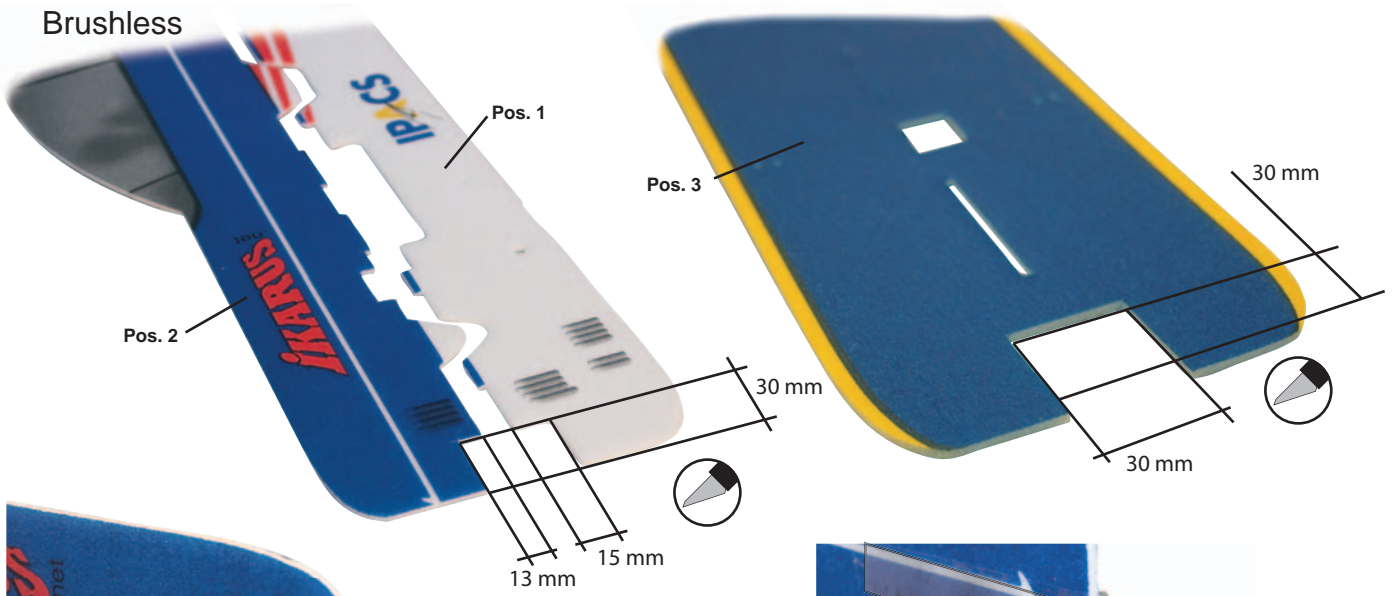

Bausatzinhalt / Kit Contents / Contenu de la boîte de construction

Pos./Part #/Pos.	Artikel Bezeichnung/Description/Désignation	Stk./Qty./Qté.
1	Rumpfunterteil / Lower fuselage / Fuselage inférieur	1
2	Rumpfoberteil / Upper fuselage / Fuselage supérieur	1
3	Rumpfvorderteil / Front fuselage / Avant du fuselage	1
4	Rumpfhinterteil / Rear fuselage / Arrière du fuselage	1
5	Höhenleitwerk / Horizontal stabilizer / Stabilisateur	1
6	Seitenruder / Vertical stabilizer / Gouverne de direction	1
7	Tragfläche rechts / Right wing / Aile droite	1
8	Tragfläche links / Left wing / Aile gauche	1
9	Querruder Rechts / Right aileron / Aileron droit	1
10	Querruder Links / Left aileron / Aileron gauche	1
11	Radschuhe / Wheel pants / Chapeau de roue	4
12	O-Ring / O-Ring / Joint O-Ring Ø2x4mm	2
13	Schraube / Screw / Vis M1,4x3mm	4
14	Schraube / Screw / Vis M2x4mm	1
15	Depronstreifen / Depron strip / Bande de Dépron ca. 500 mm	2
16	Schaumstoffkeil (Akkubefestigung) / Foam wedge (to secure battery) / Cale mousse (fixation accu)	1
17	Klebstoff UHU por / UHU por glue / Colle UHU por	1
18	Getriebeaufnahme / Gear support / Support réducteur	1
19	Getriebebefixierung / Gear mount / Fixation réducteur	1
20	Ruderhornclip / Rudder horn clevice / Clip de guignol	4
21	Ruderhorn / Rudder horn / Guignol	4
22	Gabelkopf / Clevice / Chape	4
23	Radsicherung / Wheel holder / Fixation roue	2
24	Rad / Wheel / Roue	2
25	Strebenhalter Innen / Center struts mount / Fixation hauban inférieur	1
26	Strebenhalter links / Struts mount left / Fixation hauban extérieur droit	1
27	Strebenhalter rechts / Struts mount right / Fixation hauban extérieur gauche	1
28	Radachse rechts / Right wheel axle / Axe de roue droit	1
29	Radachse links / Left wheel axle / Axe de roue gauche	1
30	Tesafilm / Adhesive tape / Ruban adhésif	1
31	Silikonschlauch/Silicone rubber sleeve / Durite silicone Ø3x5mm	2
32	ABS Fahrwerksverstärkung / ABS undercarriage reinforcement / Renfort de Train Ø25mm	2
33	ABS Gestängeabstützung / ABS Pushrod support / Support du tringle de cde	1
	CFK / CRP 0,8 x 3 x 820 mm	2
	CFK / CRP Ø 1,5 x 455 mm	1
	CFK / CRP Ø 1,5 x 395 mm	1
	CFK / CRP Ø 1,5 x 220 mm	2
	CFK / CRP Ø 1,5 x 205 mm	2
	CFK / CRP Ø 1,5 x 150 mm	4
	CFK / CRP Ø 2 x 80 mm	1
	CFK / CRP Ø 2 x 200 mm	2

Erforderliches Zubehör / Necessary Accessories / Accessoires nécessaires:

Best.Nr. / # / Réf.	Artikel-Bezeichnung / Item Description / Désignation	Stk./Qty./Qté.
2021001	Antriebsset Standard / Power set standard / Set de propulsion standard	1
171201	Lexors Servo 201	3
oder/or/ou		
171100	Lexors Servo 100	3
160533	Microregler / Micro Controller 2000 / Micro variateur	1
173570	Empfänger / Receiver / Récepteur 35 MHz	1
174070	Empfänger / Receiver / Récepteur 40 MHz	1
177270	Empfänger / Receiver / Récepteur 72 MHz	1

Antriebsset / Power set / Set de Propulsion

2021001	Standard / Standard / Standard	1
-	Brushless / Brushless / Brushless	1

Antriebs Akku / Battery / Accus de propulsion

für einfachen Kunstflug 4-5 Min. / for basic aerobatics up to max. 5 min. / pour la voltige simple, temps de vol 5 min.:

-	10 Zellen NiMH 350 mAh / 10 cell, 350 mAh battery / 10 éléments, 350 mAh	1
---	--	---

für extremen 3D-Kunstflug 15 Min. / for extreme 3D-aerobatics up to max. 15 min. / pour la voltige 3D, temps de vol 15 min.:

2027043	3 Zellen LiPo 800 mAh / 3 cell LiPo 800 mAh / Li-Poly 11,1 V, 800 mAh	1
---------	---	---



Im Webertal 22
78713 Schramberg-Waldmössingen
Bestelltelefon: +49 (0) 74 02 - 92 91-900
Hotline (0,99 €/Min.): 0900 1 - 79 50 20
Fax: +49 (0) 74 02 - 92 91-750
info@ikarus.net
www.ikarus.net